

Dell™ PowerVault™ DLT, VS, and SDLT Media Handbook Version 2.0

Notes, Notices, and Cautions



NOTE: A NOTE indicates important information that helps you make better use of your computer.



NOTICE: A NOTICE indicates either potential damage to hardware or loss of data and tells you how to avoid the problem.



CAUTION: A CAUTION indicates a potential for property damage, personal injury, or death.

Information in this document is subject to change without notice.

© 2005 Dell Inc. All rights reserved.

Reproduction in any manner whatsoever without the written permission of Dell Inc. is strictly forbidden.

Trademarks used in this text: *Dell*, the *DELL* logo, and *PowerVault* are trademarks of Dell Inc.; *Microsoft* and *Windows* are registered trademarks of Microsoft Corporation.

Other trademarks and trade names may be used in this document to refer to either the entities claiming the marks and names or their products. Dell Inc. disclaims any proprietary interest in trademarks and trade names other than its own.

March 2005

Contents

Introduction	3
Drives and Media	3
Invalid Media Symptoms	5
Reusing Type IV Media Formatted by DLT7000 or DLT8000 in VS80/DLT1 Drives	5
DLT1 and VS80 Drives.	5
VS160 Drives	5
SDLT320 and SDLT220 Drives	5
Cleaning Considerations.	7
Exhausted Cleaning Media	8
Media Handling	9
Cartridge Features	9
Media Care Guidelines	10

Introduction

This document describes the media compatibility, handling, and usage for the Dell™ PowerVault™ 110T DLT, SDLT 320/220, DLT1/VS80, and VS160. Table 1-1 shows the basic characteristics of the drives.

 **NOTE:** This document will not cover DAT72, DDS4, LTO, and LTO2 tape technologies.

Drives and Media

Table 1-1. DLT Drive Types and Basic Characteristics





	Capacity (native/compressed)	Native Speed	Primary Media
<p>Figure 1-1. DLT1</p> 	40 GB/80 GB	10.8 GB/hr	DLT (Digital Linear Tape) Type IV
<p>Figure 1-2. VS80</p> 	40 GB/80 GB	10.8 GB/hr	DLT Type IV
<p>Figure 1-3. VS160</p> 	80 GB/160 GB	28.8 GB/hr	VS1 (Value Smart) Tape
<p>Figure 1-4. SDLT220</p> 	110 GB/220 GB	39 GB/hr	SDLT (Super Digital Linear Tape) tape I

Table 1-1. DLT Drive Types and Basic Characteristics

	Capacity (native/compressed)	Native Speed	Primary Media
Figure 1-5. SDLT320	160 GB/320 GB	57 GB/hr	SDLT tape I

**Table 1-2. Primary Media Type Per Drive**

	Part No	DLT4000	DLT7000	DLT8000	DLT1	VS80	VS160	SDLT220	SDLT320
Figure 1-6. Type IV Media	340-0444	Primary	Primary	Primary	Primary	Primary	Read only*	Read only	Read only
Figure 1-7. VS1 Media	341-0117	No	No	No	No	No	Primary	No	No
Figure 1-8. SDLT Media	340-7844	No	No	No	No	No	No	Primary	Primary

* Can only read media if it was formatted with a VS80 or DLT1 drive

Invalid Media Symptoms

When a wrong media is inserted into a drive:

- Cleaning light comes on
- Media light may flash or stay on
- Tape ejects

Reusing Type IV Media Formatted by DLT7000 or DLT8000 in VS80/DLT1 Drives

Type IV media previously recorded by a DLT7000 or DLT8000 are not read compatible with DLT 4000, DLT1, or VS80 drives.

Type IV media originally formatted in DLT7000 and DLT8000 drives can be used in a VS80/DLT1 drive only if the media is first set to hardware compression level 20 GB and erased in the DLT7000/8000 drive. Otherwise the media will be automatically ejected from the DLT1 and VS80 drive.

DLT1 and VS80 Drives

DLT1 and VS80 drives use Type IV media to read and write.

DLT1 and VS80 drives can backward-read Type IV media created by DLT4000 only. They cannot read the media formatted by DLT 7000 and DLT 8000 unless the hardware compression level has been changed. See "Reusing Type IV Media Formatted by DLT7000 or DLT8000 in VS80/DLT1 Drives."

VS160 Drives

VS160 drives use VS1 media to read and write.

VS160 drives can read Type IV media only if the media was formatted by DLT1 or VS80 drive. They cannot read Type IV media formatted by DLT4000.

They cannot write to Type IV media. If a blank Type IV media is inserted in the VS160 drive, the media light will flash and media will be ejected from the drive.

SDLT320 and SDLT220 Drives

SDLT320 and SDLT220 drives use SDLT1 type media to read and write. They can backward-read all Type IV media written with DLT (DLT 4000, DLT 7000, DLT 8000, DLT1, and VS 80) drives.

SDLT320 drives can read media created with the SDLT220. When media created with the SDL220 is present in the SDLT320 drive, the media light will come on.

SDLT220 cannot read media created by SDLT320. No warning is given from the drive, but backup software will indicate bad media.





NOTE: Always label where media was originally used and formatted.

Table 1-3. Type IV, VS1, and SDLT1 Media Read/Write Compatibility

Media Types	Read by DLT4000	Read by DLT7000	Read by DLT8000	Read by DLT1	Read by VS80	Read by VS160	Read by SDLT220	Read by SDLT320
New Unformatted Type IV	Yes	Yes	Yes	Yes	Yes	No ²	No ⁶	No ⁶
Type IV written by DLT4000	Yes	Yes	Yes	Yes	Yes	No ²	Yes ¹	Yes
Type IV written by DLT7000	No*	Yes	Yes	No ^{2*}	No ^{2*}	No ²	Yes ¹	Yes
Type IV written by DLT8000	No*	No*	Yes	No ^{2*}	No ^{2*}	No ²	Yes ¹	Yes
Type IV written by DLT1	No	No	No	Yes	Yes	Yes ¹	Yes ¹	Yes
Type IV written by VS80	No	No	No	Yes	Yes	Yes ¹	Yes ¹	Yes
<i>VS1 written by VS160</i>	No	No	No	No	No	Yes	No	No
<u>SDLT1 written by SDLT220</u>	No	No	No	No ³	No ³	No ²	Yes	Yes ⁵
<u>SDLT1 written by SDLT320</u>	No	No	No	No ³	No ³	No ²	No ^{4**}	Yes

 **NOTE:** In Table 1-3, the media types formatted in bold can read and write Type IV media only.

 **NOTE:** In Table 1-3, the media type formatted in italics can read and write VS1 media. It can also read Type IV media written by VS or DLT1 drives.

 **NOTE:** In Table 1-3, the media types formatted in underlines can read and write SDLT media. They can also read Type IV media written by DLT4000, DLT7000, DLT8000, VS80, and DLT1 drives.

¹ Orange alert/media light comes on.

² The orange alert/media light illuminates and the tape is automatically ejected. The alert/media light will go off if readable media is inserted into the drive or power is cycled on the drive.

³ No lights will come on. The drive automatically ejects the tape.

⁴ No lights come on. Backup software shows bad media.

⁵ Orange (220) LED blinks indicating that a 220 formatted tape is in the drive.

⁶ No lights blink. The tape does not eject. There is no indicator on the SDLT that would indicate no data on tape.

* Under default settings the DLT 7000 and DLT8000 drives write to tape in their default density. 70 GB 2:1 compressed and 80 GB 2:1 compressed respectively. Tapes written by these devices may be read by DLT4000, DLT1, and VS80 if density 20.0 is selected on the front panel of the drive prior to formatting the tape media with a DLT7000 or DLT8000 drive. This will be data destructive.

** Density selection is not mechanically available on the front panel of SDLT drives. However, for backward compatibility reasons, an SDLT320 Density Select Utility is available on Quantum's website in the SDLT320 download area. This software utility will allow an SDLT320 drive to write in an SDLT220 format. The utility is available for both Microsoft® Windows® and Linux platforms.

Cleaning Considerations

DLT tape drives do not need periodic cleaning. Only clean DLT tape drives when a request is made by backup software, when a cleaning indicator is seen on the drive, or when troubleshooting. Although DLT 4000/7000/8000/DLT1 and VS80 drives use the same Type IV data media, they *do not* use the same cleaning tape.

Table 1-4. Cleaning Media Types



Cleaning Media	Physical Description	Characteristics	Part No	Life Span	Tracking
<p>Figure 1-9. Cleaning Tape III</p> 	Typically cream colored and labeled "DLT Cleaning Tape III."	Cleaning material inside looks like standard black media tape.	N/A NOTE: Dell does not sell this media.	20 times.	User needs to track the number of times the tape is used.
<p>Figure 1-10. DLT/VS Cleaning Tape</p> 	Light brown colored. May be designated "DLT1" or "VS80."	Cleaning material is light in color and looks more like cloth than tape. Tape leader is black in color and may appear to look like electromagnetic tape.	340-2372	20 times.	User needs to track the number of times the tape is used.
<p>Figure 1-11. VS160 Cleaning Tape</p> 	Light grey in color and labeled "VS160 Cleaning Cartridge."	Specifically designed to clean VS160 drives. NOTE: VS80/DLT1 cleaning tape may be used to clean a VS160 drive, but not recommended.	341-0118	20 times.	User needs to track the number of times the tape is used.

Table 1-4. Cleaning Media Types

Cleaning Media	Physical Description	Characteristics	Part No	Life Span	Tracking
Figure 1-12. SDLT Cleaning Tape 	Light gray in color and designated as "SDLT Cleaning Tape."	Specifically designed for SDLT220 and SDLT320 drives. If expired cleaning media is reused, the cartridge will get ejected and cleaning light will stay on. NOTE: Do not use VS160 cleaning media to clean SDLT drives.	340-3349	20 times.	Tape can track usage. On last use, the cleaning light will go off and the drive will not eject cartridge. User must manually eject cartridge and discard it from future use.

Table 1-5. Cleaning Media Compatibility

Cleaning Tape	DLT4000	DLT7000	DLT8000	DLT1	VS80	VS160	SDLT220	SDLT320
Cleaning Tape III	Yes	Yes	Yes	No	No	No	No	No
DLT1/VS Cleaning Tape	No	No	No	Yes	Yes	YES (not recommended)	No	No
VS160 Cleaning Tape	No	No	No	No	No	Yes	No	No
SDLT Cleaning Tape	No	No	No	No	No	No	Yes	Yes

Exhausted Cleaning Media

If a cleaning tape is inserted into a DLT/SDLT drive and the light remains on after tape eject, the cleaning tape may be exhausted. See the following to determine that you are using the proper cleaning tape for your drive type. If so, try another cleaning tape. Depending on the drive model, if the light does not go off, there may be a hardware fault in the drive or expired media is being used.

When an expired cleaning tape is used in a:

- DLT4000/DLT7000 drive, the tape is ejected and the cleaning light stays on.
- SDLT220/SDLT320 drive, the tape is not ejected and the cleaning light goes out the 20th time (last) the tape is used.
- DLT1/VS80 and VS160 drives, there is no method to determine that the cleaning tape is expired except to manually note usage on the check box label. It is the customer's responsibility to record usage of the cleaning tape and discard after 20 uses. The cartridge will have little or no effect on head cleaning after the recommended 20 uses.

Media Handling

Cartridge Features

Figure 1-13. Cartridge Tape

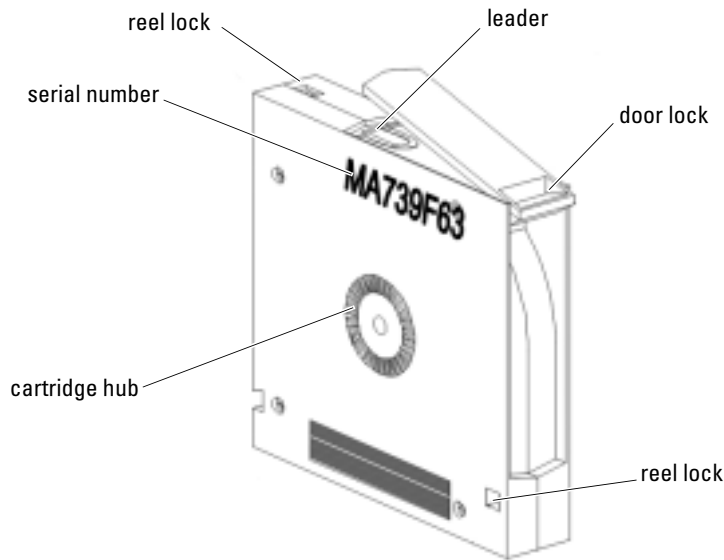

Cartridge Leader — Buckles with drive leader to pull media from cartridge. Two types, DLT tape cartridges (mylar loop) and Super DLT tape cartridges (plastic buckle with metal pin.)

Reel Locks — Prevent media reel in the cartridge from spinning when the cartridge is not loaded in a drive (ensures that proper tension of media is maintained.)

Cartridge Hub — Mechanical interconnect between the cartridge and the drive reel motor.

Write Protect Switch — Prevents overwrite or erasure of data. You can change the position of the write protect switch at any time.

Figure 1-14. DLT Tape and Super DLT Tape Media

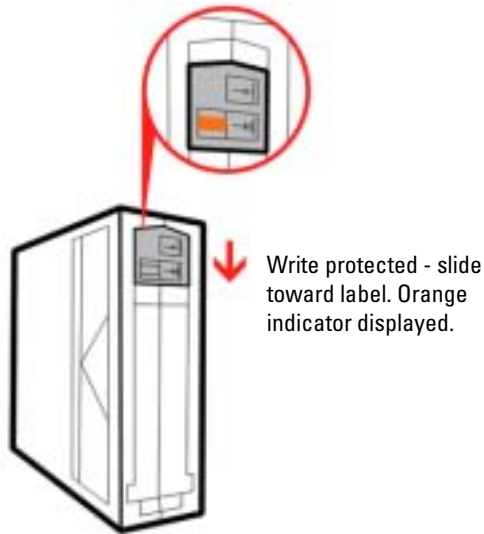
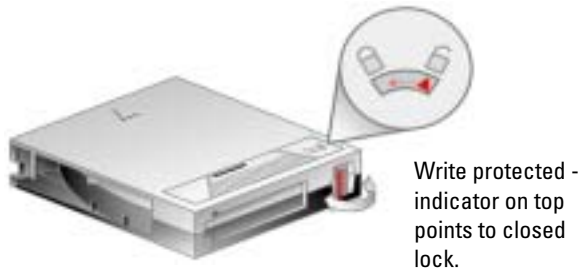

Figure 1-15. DLT Tape VS1 and DLT VS160 Media



Media Care Guidelines

DLTtape cartridges are engineered to be reliable, robust, and durable. They are manufactured to withstand 1,000,000 passes, and have a shelf life of 30 years. For best results, follow these guidelines for media care:

- Protect cartridges from shock, vibration, moisture, and magnetic fields.
- Keep media in protective cases and store vertically when not in use.

- Use the slide-in labels provided. Do not use adhesive labels or Post-it notes, and do not write on the cartridge.

Figure 1-16. Use Slide-in Label



- Write in pen not pencil. Using a pencil can introduce contaminants to the tape path.
- Use caution so loose labels in storage container don't stick to bottom of cartridge, covering the hub.
- Never touch the tape or tape leader. Dust and oils from your skin contaminate the tape and affect performance. Store media vertically in protective plastic cases.

Figure 1-17. Store Media Vertically in Protective Plastic Cases

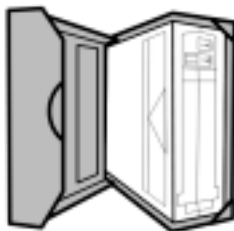

- If you drop a cartridge, perform a visual media inspection before inserting it into the drive.



NOTE: The safety of your data relies on proper care and handling of media cartridges.

Visual Media Inspection

A visual media inspection is to be performed:

- Each time a tape is loaded or changed.
- When a tape cartridge is dropped or subject to a hard physical shock.
- When a shipment of tapes shows any sign of shipping damage.
- If the DLT, DLT VS or SDLT drive becomes inoperable after loading a tape.



NOTE: If a drive error occurs, inspect the current and previous cartridge used in that drive.

Cartridge Inspection

- **Case:** Inspect the case for cracks, chips, or signs of damage.
 - **Cartridge:** Inspect the exterior of the cartridge for chips, cracks, dents, or missing screws. Gently shake the cartridge. Listen for rattling or loose pieces.
 - **Cartridge Door:** Ensure that the door is moveable and that the spring is present.
 - **Write Protect Switch:** Move the switch. It should snap into write-protected mode and write-enabled mode.
 - **Cartridge Leader:** Gently inspect the cartridge leader to verify that it has not been damaged and is in the correct position.
 - **DLTtape Cartridges:** Check the height of the leader to ensure that the loop is sticking up approximately 3/16 inch or 4 mm. Ensure that the door operates. DLT tape leader loop should be visible and undamaged.
 - **Super DLTtape Cartridges:** Check that the Super DLTtape leader buckle aligns with cartridge edge and metal pin is not bent.
-  **NOTE:** When inspecting the cartridge leader do not use anything that could leave contamination, such as a pen or pencil.

Figure 1-18. DLTtape Leader Loop

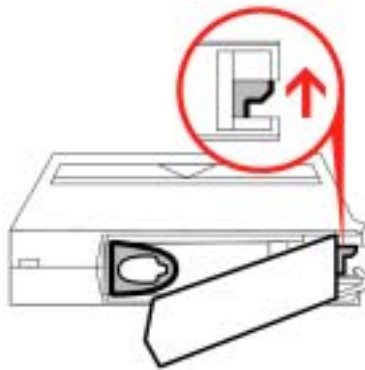
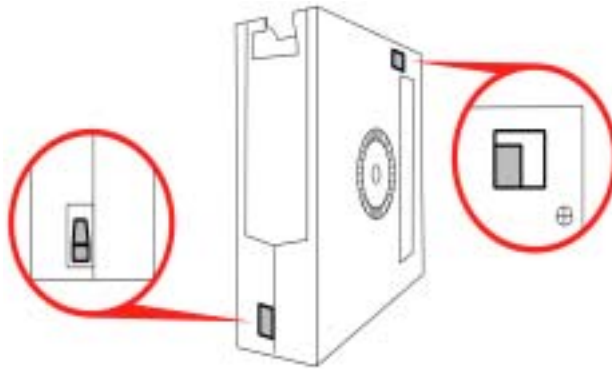

Figure 1-19. Super DLTtape Leader Buckle



- **Reel Locks:** Check that both reel locks are visible. Verify operation using a small flat-blade screwdriver. The reel locks should spring back when released. If the reel locks are not visible, do not use the cartridge.

Figure 1-20. Reel Locks



- **Cartridge Hub:** Confirm That the spring-loaded hub on the bottom of the cartridge is properly tensioned and centered. Press the hub; it will spring back if operating properly.

Figure 1-21. Cartridge Hub

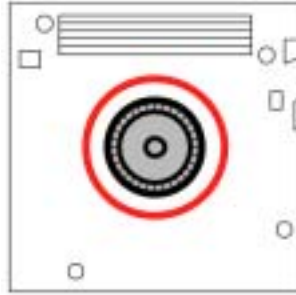

The following graphic shows how the SDLT tape latches with the cartridge leader.

Figure 1-22. SDLT Tape Latch



The following graphic shows how the loop on the Type IV media is engaged by the cartridge leader on the DLT/VS80 drives.

Figure 1-23. Type IV Media Engagement



Cartridge Damage Examples

Figure 1-24. DLT Cartridge — Leader missing (swallowed cartridge leader or broken tape)



Figure 1-25. DLT Cartridge — Broken leader loop (not always this obvious)



Figure 1-26. Media wrapped too loosely (improper tension)



Figure 1-27. SDLT Cartridge — Bent media buckle



SDLT Media

When inspecting an SDLT media cartridge, refer to the following diagrams to check the leader buckles on the media.

Figure 1-28 shows a good cartridge. Note the plastic hooks resting on the cartridge rails and bar parallel to the cartridge.

Figure 1-28. Good SDLT Leader Buckles

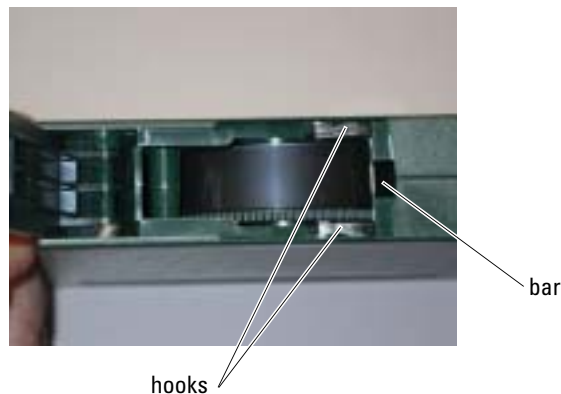

Tests have shown that dropping the media can cause an excessive amount of stress to the spring-loaded cartridge hub on impact. This amount of stress will pull the tape media further into the media cartridge and bend the leader buckles.

See Figure 1-29 to identify bent-in leader buckles. Note that the plastic hooks are bent inward and not resting on the cartridge wall. Also the bar is not parallel to the cartridge. It is usually the HUB side of the cartridge that gets more pulled.

Figure 1-29. SDLT Bent-In Leader Buckles

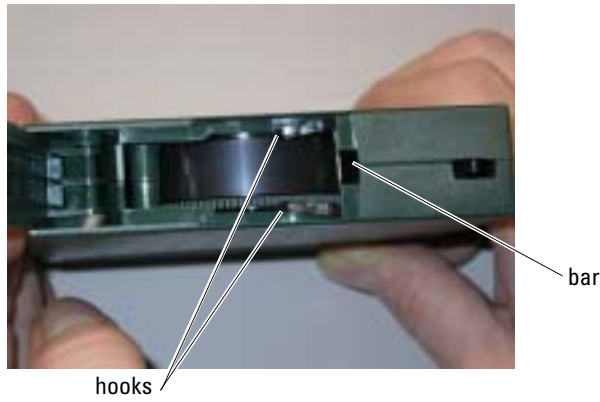

Media with bent-in leader buckles have been known to cause the tape drive to drop the leader when the drive tries to load the media into the take-up reel.

Cartridge Storage

When storing cartridge, avoid moisture and direct sunlight. Exposure to moisture or sunlight can deform or ruin media.

Table 1-6. Normal Storage Conditions (Nonarchival)

Temperature	Relative Humidity
<ul style="list-style-type: none">• Between 61°F and 90°F (16°C and 32°C)• Wet bulb temperature 78°F (26°C)	Between 20% and 80%

Table 1-7. Archival Storage Conditions (for one or more years)

Temperature	Relative Humidity
Between 64°F and 79°F (18°C and 26°C)	Between 40% and 60%

Media Do's and Do Not's

The following should be done when handling media.

- Store cartridges in their protective cases.
- Handle cartridges with great care.
- Store cartridges vertically.
- Align cartridges so the grooves interlock.
- Inspect cartridges prior to each use.
- Unload cartridges prior to powering down the drive.
- Allow a 24-hour conditioning period to the operating temperature and humidity before using new or stored cartridges.

The following should not be done when handling media.

- Touch the media or leader with bare fingers.
- Use pens or pencils during cartridge inspection.
- Drop cartridge.
- Stack cartridges horizontally.
- Disassemble cartridges.
- Use adhesive labels.
- Ship cartridges in drive.
- Store near magnetic fields (for example, speakers, monitors, electric motors, power supplies, and so forth).
- Use a cartridge that fell from 3 ft or higher.